

2115KIT - 2115KIT

KIT SPECIFICO - SPECIFIC KIT - KIT SPECIFIQUE - SPEZIFISCHES KIT - KIT ESPECÍFICO - KIT ESPECÍFICA

YAMAHA MT-09 (2013)

N°	Descrizione	Caratteristiche	Codice	Quantità	
1	Supporto - Support - Support Halterung - Soporte - Apoio	Sp. 3mm	GL2544	2 (Dx;Sx)	
2	Vite - Screw Vis - Schraube Tornillo - Parafuso	TECF M8x30	830TECF	4	
3	Dado - Bolt - Ecrou Mutter - Tuerca - Porca	Auto Bloccante Flangiato M8	8DADIAFLN	4	
4	Distanziale - Spacer Entretoise - Distanzstueck Distanciador - Espaçador	Ø18x17 Foro 8.5mm	C18L17F8,5T	4	
5	Distanziale - Spacer Entretoise - Distanzstueck Distanciador - Espaçador	Ø18x12 Foro 8.5mm	C18L12F8,5T	4	
6	Particolari Inclusi Nel Kit Viteria Della Piastra Components Included In The Fitting Kit Of The Plate Pièces Inclues Dans Le Kit De Vis De La Platine Die Einzelnen Teile Sind Bei Montagekit Der Platte Enthalten Despieces Incluidos En El Kit De Anclajes De La Parrilla Explodiu Incluído No Kit As Âncoras Da Grelha	-	-	-	-

2115KIT - 2115KIT

KIT SPECIFICO - SPECIFIC KIT - KIT SPECIFIQUE - SPEZIFISCHES KIT - KIT ESPECÍFICO - KIT ESPECÍFICA

YAMAHA MT-09 (2013)

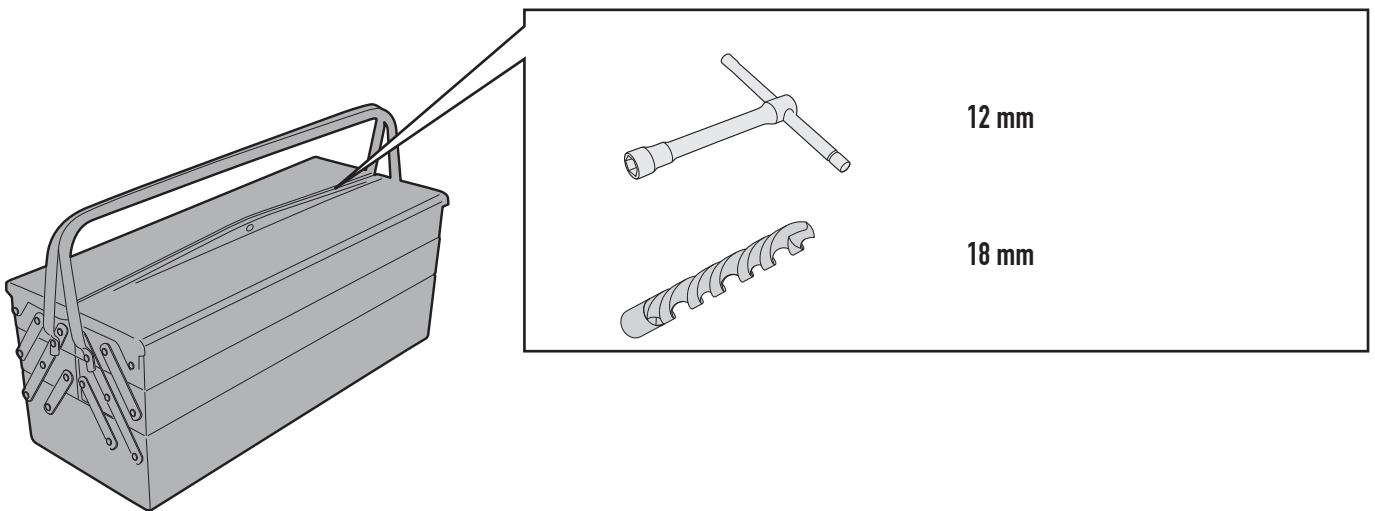

2115KIT - 2115KIT

KIT SPECIFICO - SPECIFIC KIT - KIT SPECIFIQUE - SPEZIFISCHES KIT - KIT ESPECÍFICO - KIT ESPECÍFICA

YAMAHA MT-09 (2013)

